

ANLEITUNG / INSTRUCTIONS

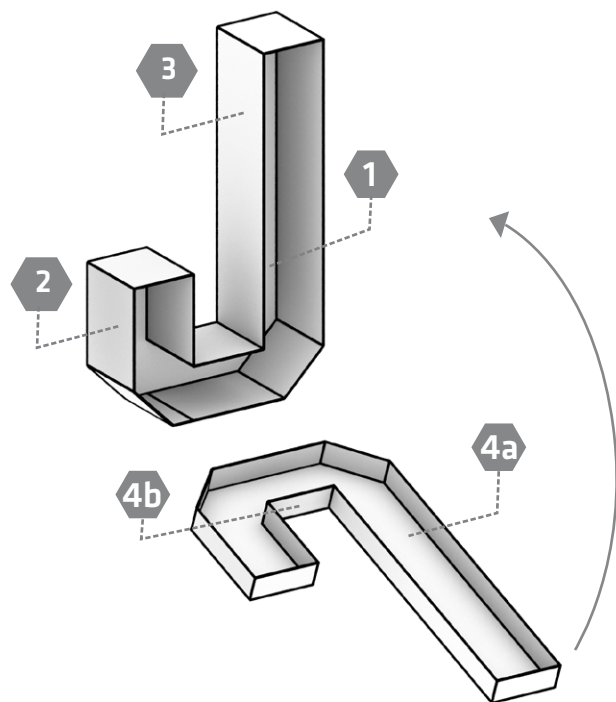

voestalpine Klangwolke
Die Wolke im Netz
<http://www.aec.at/klangwolke>

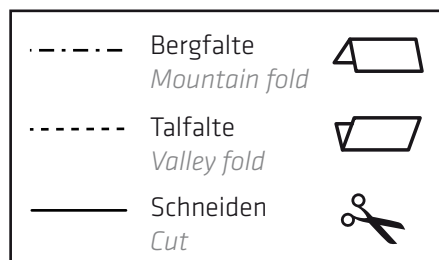

1. Bastle den unteren Teil des Buchstaben aus starkem Papier oder Karton (1-3, 200 g oder mehr).
2. Gib die LEDs hinein.
3. Schneide die Vorderseite (4) aus Transparentpapier o.ä. aus und verschlieÙe damit den Buchstaben.

1. Build the base of the letter out of stiff paper (1-3, 200 gms or more)
2. Insert LEDs
3. Close the letter with the „front side“(4) made out of a translucent paper material

